

# notifi<sup>TM</sup>

a l e r t

wireless plug-in doorbell  
with smartphone notifications

## Owner's Manual

Model: 3011



# Introduction

## Table of Contents

INTRODUCTION . . . . .	3
SETUP . . . . .	4-6
HOW TO USE . . . . .	7-10
CARE AND CLEANING . . . . .	10
FAQS . . . . .	11-12

## Thank You for Purchasing Notifi™ Doorbell System

Welcome to Notifi by HeathZenith. This manual will help setup the Notifi system. Please read and understand this entire manual before attempting to assemble, install, or operate the Notifi system. For additional support and videos, go to [www.heath-zenith.com/notifi](http://www.heath-zenith.com/notifi).

### IMPORTANT INFORMATION

- Minimum system requirement for the Notifi app is iOS 10.0 or higher and Android 6.0 or higher.

## Notifi Alert Features

- Smart Phone Notifications
- Programmable Muting

## CAUTION

To maintain the compliance with the RF exposure guideline, place the base unit at least 7.875" (20 cm) from nearby persons.

# Introduction

## Specifications

### Power Requirements:

Chime: 120 VAC, 60 Hz

Push Button: Type CR2032 3V battery (included)

**Push Button Transmission Range:** 100 feet

**Volume:** Adjustable

**Number of Tunes:** 11

**Operating Temperature (Push Button):** -13 to +120°F (-25°C to +50C)

**Operating Temperature (Alert Chime):** +32 to +104°F (0°C to +40C)

**Minimum System Requirements for the Notifi App:** iOS 10.0 or higher and Android 6.0 or higher, Broadband Internet Connection with Home Wi-Fi®: Download speed is 3 MB/s and upload speed is 1 MB/s

## You Will Need (not included)

- Password for your home network
- Broadband Internet connection with home Wi-Fi router
- Phillips screwdriver
- Flat-head screwdriver

## Carton Inventory

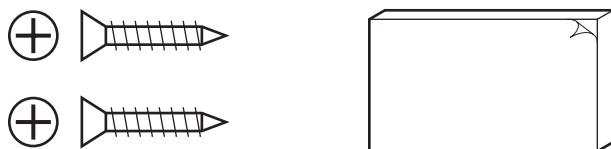
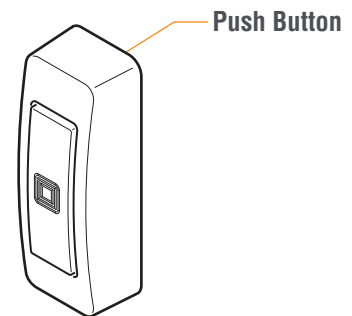
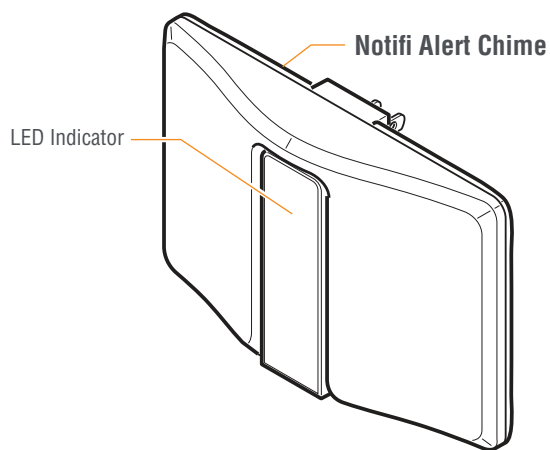

Screws (#6 x 3/4") and Double-Sided Tape (for Push Button)

# Setup

## 1 Install the Notifi Alert Chime

1. Plug in the chime at the desired location. **NOTE:** It is recommended that the chime be plugged into the bottom wall receptacle with the chime hanging below the receptacle as shown.

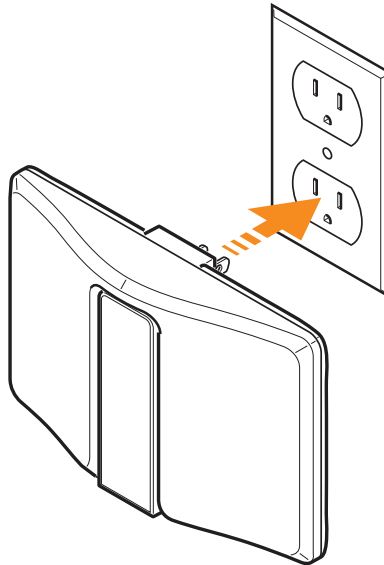

## 2 Remove the Notifi Alert Push Button Battery Tab

### **⚠ WARNING**

To prevent possible **SERIOUS INJURY** or **DEATH**:

- NEVER allow small children near batteries.
- If battery is swallowed, immediately notify doctor.

1. Remove the backplate of the Notifi Alert push button by pushing in tab on the bottom with a small flathead screwdriver (not included).
2. Remove the orange battery tab.

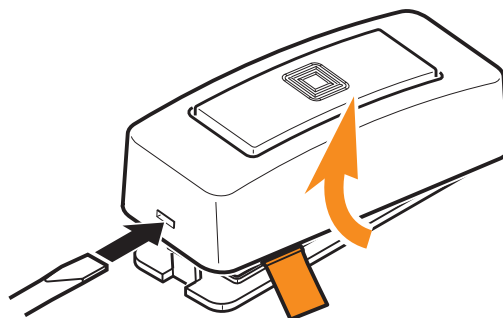

# Setup

## 3 Test the Notifi Alert Push Button and Chime

**IMPORTANT:** Do not permanently mount the push button until the push button and chime are working properly.

1. Temporarily position the push button where it will be mounted.
2. Press the push button to verify the chime and push button work correctly.
3. If the chime does not sound, move the chime closer to the push button and test again.

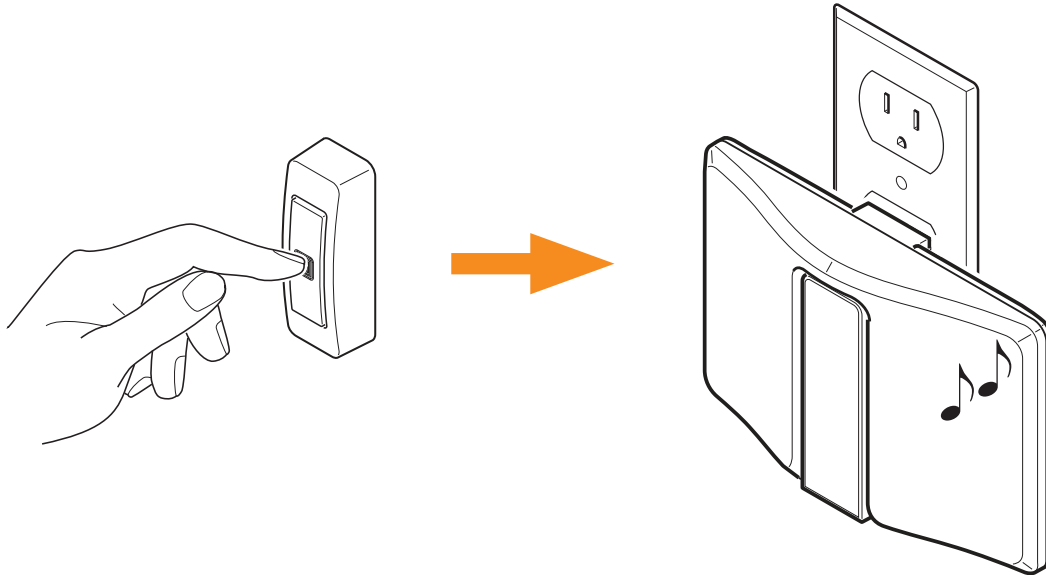

## 4 Install the Notifi Alert Push Button

1. Secure the push button backplate to the door jamb or wall with screws or double-sided tape.
2. Slide the top of the Notifi Alert push button cover down onto the backplate and press the bottom of the push button cover against the backplate until it snaps onto the backplate.

### SCREW INSTALL

Remove material in screw holes (if needed) before mounting with screws.

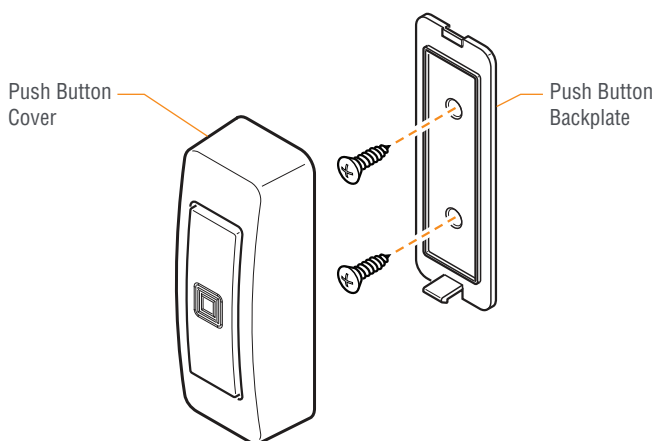

### DOUBLE-SIDED TAPE INSTALL

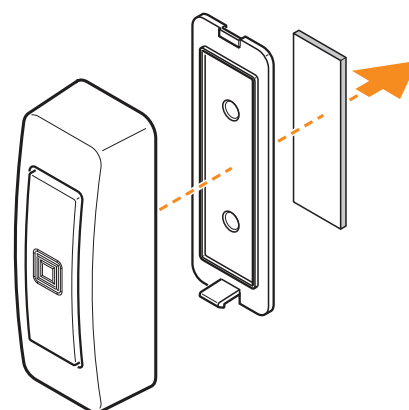

# Setup

## 5 Download the Notifi App



### iOS Devices

Go to the App Store<sup>SM</sup> and search for the “Notifi Products” app and download.

### Android Devices

Go to the Google Play<sup>TM</sup> store and search for the “Notifi Products” app and download.

## 6 Setup the Notifi App

**IMPORTANT:** Your home password will be required during this process.

1. Open the Notifi app and create an account.
2. On your mobile device, go to **Settings > Wi-Fi**. Select the “**Notifi Alert XXXXXX**” (“XXXXXX” represents the unique MAC address of each Notifi Alert Chime) from the available Wi-Fi networks.
3. Once connected, open the Notifi app and click the “Add Notifi System” button.
4. Select “YES” to start the setup and the app will guide you through the remaining steps.





**NOTE:** Your username will be your email address. Your password must be a minimum of 8 characters or a maximum of 12 characters. Alpha numeric and/or special characters may be used.

**IMPORTANT:** The password must include at least 1 number, 1 upper case letter, 1 lower case letter, and 1 special character.

# How to Use

## Systems Tab

The Systems tab is the “home screen” for all of your Notifi systems. From here you can access the following choices:



- Notifi systems – The Systems tab lists all Notifi systems available. Tap on the desired Notifi system to view all connected accessories.
-   – Selecting the “Mute” button will immediately mute your chime. Muting the chime from this location will override any scheduled mute settings. Select “Unmute” to return to the scheduled mute settings.
-  – Selecting the “Gear” icon next to a Notifi system will allow you to adjust different settings for that Notifi system.
-  **Add Notifi System** – At the bottom of the list of Notifi systems is this selection. Tap on “Add Notifi System” to learn how to add additional systems to your Notifi app. This selection also launches the setup process when the mobile device is connected to a new Notifi product.
- **Logout** – You may choose to logout of the Notifi app if you want to log into another account. Also, once logged out, you will be asked to log back in if you receive a notification from a Notifi system on this device.
- **Need help?** – Selecting this link will take you to the Notifi FAQ website where you will have access to additional help features as well as contacting HeathZenith technical service department (1-800-858-8501).
-  – Tap on this icon to access additional information about the Notifi app.

## Events

An event is created when the push button is pressed or an accessory is activated. To view an event, tap the  tab. Then tap the name of the Notifi system you would like to view events for. The events will be listed chronologically.

To delete an event, swipe left across the event you wish to delete. Then tap the trashcan icon .

## Notifi Software Updates

Whenever a firmware update is available for a Notifi product, the “gear” icon  next to the applicable product on the “Systems” screen will change to a download icon . This icon will remain on the screen until the firmware update has been completed. **NOTE:** *A reminder pop-up screen will also appear each time you log into the Notifi app reminding you that a firmware update is available. This pop-up screen will continue to appear until the firmware has been updated.*

## Alert LED Indicator

The Notifi Alert has a LED indicator on the face of the chime. This LED indicator offers additional information as to the status of the Notifi Alert chime. See the FAQ section on page 12 for additional details.

## Notification Settings

 > **Feature Settings > Notifications**

The notifications settings screen allows you to enable, schedule, and disable push notifications and email notifications.

**IMPORTANT:** *With any setting changes make sure you press the Save button  in the upper right corner if you want to keep your changes.*

# How to Use

## Mute Settings

### > Feature Settings > Mute Settings

The Notifi system allows you to mute your chime from within the Notifi app. The mute settings allow you to schedule times during the day when the chime should be muted. **NOTE:** Muting the chime does not disable notifications.

**Default (2 Hour):** Mutes the chime for a period of two hours from the time this selection is made. This selection may be turned OFF at any time.

**Weekday:** Allows for a specific time during the day to be selected to mute the chime. The scheduled time is applied to all selected days. This selection may be turned OFF at any time.

**Weekend:** Allows for quick scheduling of weekend only times when the chime is to be muted. This selection may be turned OFF at any time.

**IMPORTANT:** The chime can be muted quickly from the Systems selection tab by selecting “Mute” under the selected Notifi system. Any scheduled mute settings will be overridden while the chime is muted from the Systems tab. Select “Unmute” to return to the scheduled mute settings.

**IMPORTANT:** With any setting changes make sure you press the Save button  in the upper right corner if you want to keep your changes.

## Volume Setting

### > Feature Settings > Speaker Volume

The Notifi Alert’s speaker volume can be adjusted by using the slide control at the bottom of the app screen.

## System Name/Photo Icon

### > Advanced Settings > System Name/Photo

The Notifi systems on your account can be renamed at any time.

A photo can be added to represent each Notifi system on your mobile device. The photo will be placed next to the selected Notifi system. **NOTE:** The photo is stored on the Notifi server and will appear on any device logged into or sharing this account.

**IMPORTANT:** With any setting changes make sure you press the Save button  in the upper right corner if you want to keep your changes.

## Add a Notifi Accessory

### > Advanced Settings > Add Notifi Accessory

Up to 10 wireless accessories (sold separately) may be linked to your Notifi Alert. Follow the instructions on the screen to connect each new accessory.



# How to Use

## Accessory Name/Photo Icon

**Systems Tab > Notifi System > Accessory\* >  > Accessory Name/Photo**

\* Tap the arrow next to the Notifi system to show the Notifi accessories connected to that system.

The Notifi accessories on your account can be renamed at any time.

A photo can be added to represent each Notifi accessory on your mobile device. The photo will be placed next to the selected Notifi accessory. **NOTE:** The photo is stored on the Notifi server and will appear on any device logged into or sharing this account.

**IMPORTANT:** With any setting changes make sure you press the Save button  in the upper right corner if you want to keep your changes.

## Accessory Sounds

**Systems Tab > Notifi System > Accessory\* >  > Sounds**

\* Tap the arrow next to the Notifi system to show the Notifi accessories connected to that system.

The Notifi Alert chime has eleven tunes available for each accessory. A unique sound can be assigned to each accessory.

Auld Lang Syne	Beethoven's Fifth	Birthday Celebration
Ding-Dong	Ding	Relax Triplet
Short Westminster	Shorty	We Wish You A Merry Christmas
Westminster	Whittington	

## Change the Notifications Email

** > Account Settings > Update Email**

Use this to change the email address where notifications will be received. **NOTE:** Changing this email address will not change the Username email address used to log into your Notifi account.

## Change Account Password

** > Account Settings > Update Password**

Use this to change the password for your Notifi account.

## Multiple Guest Users

** > Advanced Settings > Manage Multiple Users**

The Notifi system allows you to control multiple “guest” users within your account. These users will receive notifications when the Notifi Alert is activated. The “guest” users will not be able to access any of the Notifi settings you have setup.

To add a “guest” user to your multiple user list, tap the “Add Viewers” button and type their email address in the “To:” field, then tap the “Send” button. The “guest” user will receive an email inviting them to view your system. They will need to download the Notifi app and create their own account before they are able to access your Notifi system.

You can turn off their access to your Notifi system at any time by tapping their username in the list. You can turn it back on by tapping their username again.

# How to Use

## Deleting a Notifi Accessory

Systems Tab > Notifi System > Accessory\* >  > Delete Accessory

\* Tap the arrow next to the Notifi system to show the Notifi accessories connected to that system.

This selection will delete the currently selected Notifi accessory. To reconnect the accessory to a Notifi system, go to “Add a Notifi Accessory”.

## Deleting a Notifi System

Systems Tab > Notifi System

**NOTE:** When a Notifi device has been physically damaged and is no longer working, this process will remove the system from the Notifi app.

- Slide the Notifi system name on the Systems Tab to the left.
- Tap the trashcan icon  to delete the system.

**NOTE:** Deleting a Notifi system on the homepage does not reset the Notifi Alert to the factory settings. If you want to move the chime to a different account, see *Factory Reset* below.

## Factory Reset

 > Advanced Settings > Factory Reset

Reset the Notifi Alert chime to the original factory settings if you want to move this Notifi Alert to a different account.

### NOTICE

When resetting the Notifi Alert chime:

- The Notifi Alert chime will be reset to factory settings and will no longer be connected to your Wi-Fi or the Notifi app.
- All events will be deleted from your account.
- All settings will be deleted.
- The Notifi Alert chime will be removed from your Heath/Zenith account.

# Care and Cleaning

## Chime and Push Button

Use a dry cloth to clean the chime and push button. Do not use any fluids on the chime or push button.

# FAQs

## WHY WON'T THE NOTIFI SYSTEM CONNECT TO MY WIRELESS NETWORK (HOME ROUTER)?

To resolve issues with the Notifi Alert System not connecting to the home router:

- Using your mobile device, test the Wi-Fi signal at the location of the Notifi Chime. If the Wi-Fi signal at the chime is low, move the Alert chime closer to the router or get a Wi-Fi extender.
- Verify you are connecting to the correct wireless network and inputting the correct network password. If you are unsure of your network password, contact the router manufacturer.
- Check if there is a firewall device installed (e.g. SonicWall, Zywall). If there is a firewall, the UDP timeout (UDP port 80 and 443) must be set to 180 seconds or greater for both inbound and outbound. If you are unsure how to set these, contact the firewall manufacturer.
- If any changes have been made to the wireless network name, password or security, you must setup the Notifi System again. Unplug the Notifi Alert chime for 30 seconds and plug the chime back into the wall outlet. Follow step 6 in the Setup section to reconnect the chime to your app.

## WHY AM I NOT RECEIVING NOTIFICATIONS?

- Ensure that your Notifi System is online and the blue LED on the Alert chime has a steady glow.
- Ensure notifications for your mobile device are turned ON.
- Ensure that your mobile device has a data connection (Wi-Fi or cellular data).
- Ensure that the notifications settings in the Notifi App is turned on. Within the Notifi app, follow:  
 > **Feature Settings > Notifications**  
**NOTE:** Check notification scheduling to ensure notifications have not been turned OFF.
- **NOTE:** Unplug the Alert chime for 30 seconds and plug back in. Wait 5 minutes for the Notifi system to fully boot and recheck.

## WHY DOES MY CHIME NOT RING WHEN I PRESS THE PUSH BUTTON?

- Ensure that the power is ON to the chime.
- Ensure the battery in the push button is good and the battery is installed correctly.
- Move the chime closer to the push button and test again.
- The chime and push button are not synced. Re-sync the chime and push button. See “Add a Notifi Accessory”, page 8.
- Check mute scheduling to ensure the chime is not muted.

## WHY IS MY ALERT CHIME SOUNDING IF NO TRANSMITTERS ARE BEING ACTIVATED?

Your Alert chime is receiving interference from another wireless device. Follow the steps below to reset your push button's code and re-sync the push button to the chime. **NOTE:** If more than one accessory is connected to the Alert chime, each accessory must be reset in the same manner as the push button described below.

Remove the push button from the Notifi app:

- On the Systems tab, slide the push button to the left and press “Delete”.

Reset the push button:

- Remove the push button battery.
- Reinstall the battery and immediately press the push button for 10 to 15 seconds.

Re-sync the push button and the Alert chime:

- After performing the steps above, use the Accessory Settings (  > **Advanced Settings > Add Notifi Accessory**) to re-sync the push button (and any additional accessories) to the chime.

# FAQs

## HOW DO I CHANGE ACCOUNTS?

Perform a factory reset on the Notifi Alert chime. See *Factory Reset*, page 10, for instructions.

## WHAT ARE THE DIFFERENT LED INDICATORS?

The LED indicator on the Alert chime shows different Notifi Alert status indicators:

LED INDICATOR	STATUS
Blinks twice – pause – blinks twice continuously.	Wi-Fi not connected during initial installation.
Glow steady Blue.	Wi-Fi is connected (Normal state).
LED indicator is off.	Push button is pressed.
Slow blinking continuously.	Wi-Fi not connected after initial installation.

## 1 Year Limited Warranty

This is a “Limited Warranty” which gives you specific legal rights. You may also have other rights which vary from state to state or province to province.

For a period of one year from the date of purchase, any malfunction caused by factory defective parts or workmanship will be corrected at no charge to you.

**Not Covered** - Repair service, adjustment and calibration due to misuse, abuse or negligence, batteries, and other expendable items are not covered by this warranty. Unauthorized service or modification of the product or of any furnished component will void this warranty in its entirety. This warranty does not include reimbursement for inconvenience, installation, setup time, loss of use, unauthorized service, or return shipping charges.

This warranty covers only HeathCo LLC assembled products and is not extended to other equipment and components that a customer uses in conjunction with our products.

THIS WARRANTY IS EXPRESSLY IN LIEU OF ALL OTHER WARRANTIES, EXPRESS OR IMPLIED, INCLUDING ANY WARRANTY, REPRESENTATION OR CONDITION OF MERCHANT ABILITY OR THAT THE PRODUCTS ARE FIT FOR ANY PARTICULAR PURPOSE OR USE, AND SPECIFICALLY IN LIEU OF ALL SPECIAL, INDIRECT, INCIDENTAL, OR CONSEQUENTIAL DAMAGES. REPAIR OR REPLACEMENT SHALL BE THE SOLE REMEDY OF THE CUSTOMER AND THERE SHALL BE NO LIABILITY ON THE PART OF HEATHCO LLC FOR ANY SPECIAL, INDIRECT, INCIDENTAL, OR CONSEQUENTIAL DAMAGES, INCLUDING BUT NOT LIMITED TO ANY LOSS OF BUSINESS OR PROFITS, WHETHER OR NOT FORESEEABLE.

Some states or provinces do not allow the exclusion or limitation of incidental or consequential damages, so the above limitation or exclusion may not apply to you.

**Please keep your dated sales receipt, it is required for all warranty requests.**

PMN: WLTRX3011

This device complies with Part 15 of the FCC Rules and RSS-210 of Industry Canada. Operation is subject to the following two conditions: (1) this device may not cause harmful interference, and (2) this device must accept any interference received, including interference that may cause undesired operation.

The user is cautioned that changes or modifications not expressly approved by the party responsible for regulatory compliance could void the user's authority to operate the equipment.

NOTE: This equipment has been tested and found to comply with the limits for a Class B digital device, pursuant to part 15 of the FCC Rules. These limits are designed to provide reasonable protection against harmful interference in a residential installation. This equipment generates, uses and can radiate radio frequency energy and, if not installed and used in accordance with the instructions, may cause harmful interference to radio communications. However, there is no guarantee that interference will not occur in a particular installation. If this equipment does cause harmful interference to radio or television reception, which can be determined by turning the equipment off and on, the user is encouraged to try to correct the interference by one or more of the following measures:

- Reorient or relocate the receiving antenna.
- Increase the separation between the equipment and receiver.
- Connect the equipment into an outlet on a circuit different from that to which the receiver is connected.
- Consult the dealer or an experienced radio/TV technician for help.

MADE IN CHINA

Please call **1-800-858-8501** (English speaking only) for assistance before returning product to store.

8:00 AM to 5:00 PM CST (M-F).

You may also write\* to:

**HeathCo LLC**  
**P.O. Box 90045**  
**Bowling Green, KY 42102-9045**  
ATTN: Technical Service

*\* If contacting Technical Service, please have the following information available:  
Model Number, Date of Purchase, and Place of Purchase.*

Apple and the Apple logos are trademarks of Apple Inc., registered in the U.S., and other countries. App Store is a service mark of Apple Inc.

Google Play is a trademark of Google Inc.

Android is a trademark of Google Inc.

Wi-Fi® is a registered trademark of Wi-Fi Alliance